

# Panasonic

Integrated Telephone System

## Operating Instructions

Model No. **KX-TSC11HGW**

Pulse-or-tone dialing capability

Preparation

Basic Operation

Advanced Operation

Useful Information



Caller ID Compatible

**PLEASE READ BEFORE USE AND SAVE.**

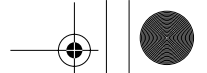

# Before Initial Use

***Thank you for purchasing your new Panasonic integrated telephone.***

Caller ID, where available, is a telephone company's service. After subscribing to Caller ID, this phone will display a caller's phone number.

## For your future reference

Serial No. \_\_\_\_\_ Date of purchase \_\_\_\_\_  
(found on the bottom of the unit)

Name and address of dealer \_\_\_\_\_

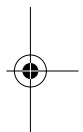

## Copyright:

This material is copyrighted by Panasonic Communications (Malaysia) Sdn. Bhd., and may be reproduced for internal use only. All other reproduction, in whole or in part, is prohibited without the written consent of Panasonic Communications (Malaysia) Sdn. Bhd.

© 2004 Panasonic Communications (Malaysia) Sdn. Bhd. All Rights Reserved.

## Accessories (included)

Handset (p. 6)

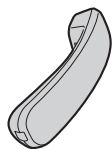

one

Handset Cord (p. 6)

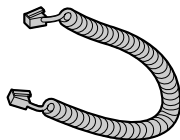

one

Telephone Line Cord (p. 6)

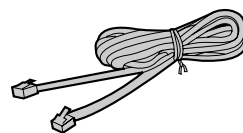

one

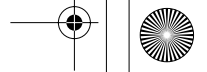
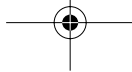

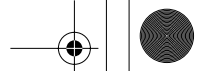

# Contents

## Preparation

|  |          |
|--|----------|
| <b>Location of Controls</b> .....                    | <b>4</b> |
| <b>Display</b> .....                                 | <b>5</b> |
| <b>Settings</b> .....                                | <b>6</b> |
| Installing the Batteries .....                       | 6        |
| Connecting the Handset/<br>Telephone Line Cord ..... | 6        |
| Programming Summary .....                            | 7        |
| Time and Date .....                                  | 8        |
| Dialing Mode .....                                   | 10       |
| LCD Contrast .....                                   | 11       |
| Ringer Volume .....                                  | 11       |
| Display Language .....                               | 12       |

## Basic Operation

|   |           |
|---|-----------|
| <b>Making Calls</b> .....                                       | <b>13</b> |
| <b>Answering Calls</b> .....                                    | <b>14</b> |
| <b>Caller ID Service</b> .....                                  | <b>14</b> |
| <b>Using the Caller List</b> .....                              | <b>15</b> |
| Viewing the Caller List .....                                   | 15        |
| Calling Back from the Caller<br>List .....                      | 17        |
| Editing the Caller's Phone<br>Number .....                      | 17        |
| Storing Caller List Information in<br>the Phone Book List ..... | 18        |
| Erasing Caller List<br>Information .....                        | 19        |

## Advanced Operation

|  |           |
|--|-----------|
| <b>Phone Book</b> .....  | <b>20</b> |
| Storing Names and Phone<br>Numbers in the Phone Book<br>List .....     | 20        |
| Dialing from the Phone Book ..   | 23        |
| Chain Dial .....   | 24        |
| Editing .....  | 25        |
| Erasing .....  | 26        |
| <b>Special Features</b> .....  | <b>27</b> |
| Temporary Tone Dialing<br>(For Rotary or Pulse Service<br>Users) ..... | 27        |
| Using the PAUSE Button<br>(For PBX Line/Long Distance<br>Calls) .....  | 27        |
| For Call Waiting Service<br>Users .....                                | 28        |
| RECALL Button .....  | 28        |
| Setting the Password .....   | 29        |
| Dial Lock .....  | 30        |
| Call Restriction .....   | 31        |

## Useful Information

|                                  |           |
|----------------------------------|-----------|
| <b>Wall Mounting</b> .....       | <b>32</b> |
| <b>Battery Replacement</b> ..... | <b>33</b> |
| <b>Troubleshooting</b> .....     | <b>34</b> |
| <b>Safety Instructions</b> ..... | <b>36</b> |
| <b>Specifications</b> .....      | <b>38</b> |

Preparation

Basic Operation

Advanced Operation

Useful Information

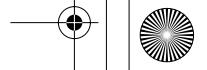
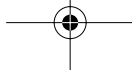

## Location of Controls

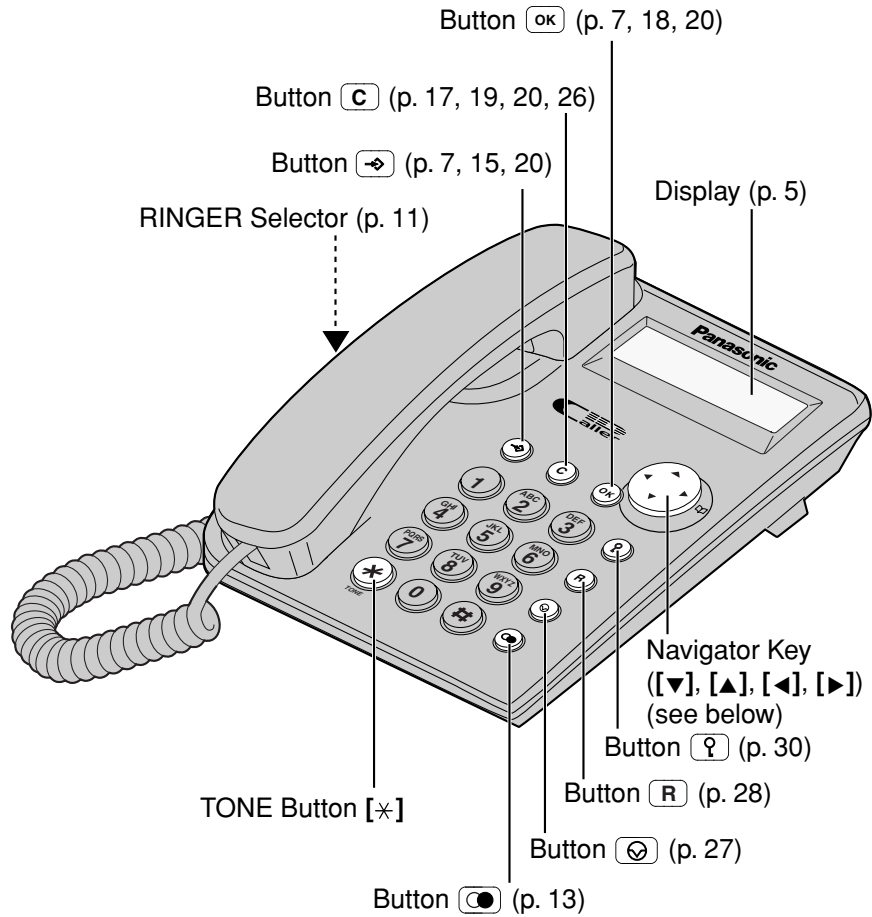

### How to use the Navigator key

This key has four active areas that are indicated by arrows.

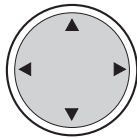

- Pressing the up and down arrows allows you to enter the Caller List and select the function menu, the Caller List and the Phone Book List. The up and down arrows are also used to adjust the receiver volume while talking.
- Pressing the right and left arrows allows you to enter the Phone Book List and move the cursor when entering items.

Throughout these Operating Instructions, the navigator key is indicated by the arrows [▼], [▲], [◀] or [▶].

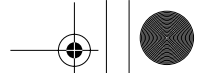

## Display

1234567890123456  
 88:88<sup>AM</sup>88/88 NEW x8

(This display shows all of the possible configurations.)

10 MISSED CALLS  
 12:34 24/11

While the unit is not in use, the display shows the current time and date, and the number of new calls.

0:00 31/12

If the display continuously shows “0:00 31/12” or “12:00<sup>AM</sup> 31/12”, the clock needs adjustment (p. 8, 9).

01-06-35  
 12:34 24/11

During a conversation, the display shows the length of the call (Ex. 1 hour, 6 minutes and 35 seconds).

1114447777  
 11:50 23/11 NEW x3

This is a display from the Caller List. The display shows:

- the caller's number,
- the time and date of the last call (Ex. Nov. 23, 11:50),
- the caller's information is new and has not been viewed (“NEW” is displayed), and
- the number of times called (Ex. 3 times).

Preparation

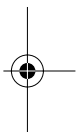

: The dial lock mode is set (p. 30).

: The unit enters in the Phone Book List (p. 18).

: was pressed while the handset is on the cradle (p. 13).

: This display flashes, when the battery power is low. Replace the batteries (p. 33).

P : was pressed while dialing or storing phone numbers.

F : was pressed while storing phone numbers.

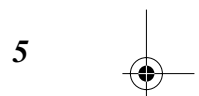
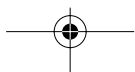

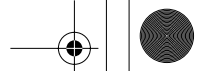

## Settings

### Installing the Batteries

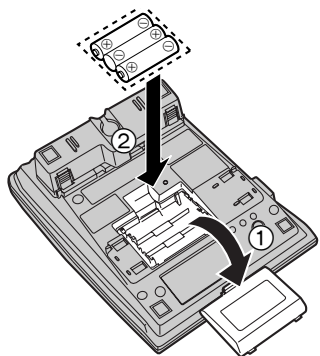

- 1 Press down in the direction of the arrow and remove the battery cover (①).
- 2 Install the batteries in the proper order as shown (②), matching the correct polarity.
- 3 Close the battery cover.

- Batteries are not included in the unit.
- Install three high quality “AA” size Alkaline (LR6) or Manganese (R6, UM-3) batteries. We recommend to use Panasonic Alkaline batteries.  
Battery life is: —about six months in use of Alkaline batteries.  
—about three months in use of Manganese batteries.  
Battery life may depend on usage conditions and ambient temperature.
- Make sure batteries were inserted properly in phase to ensure the functionality of this unit.

**THE UNIT MAY NOT WORK PROPERLY WITHOUT BATTERIES.**

### Connecting the Handset/Telephone Line Cord

After connection, lift the handset to check for a dial tone.

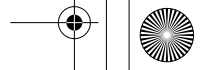
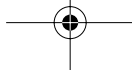
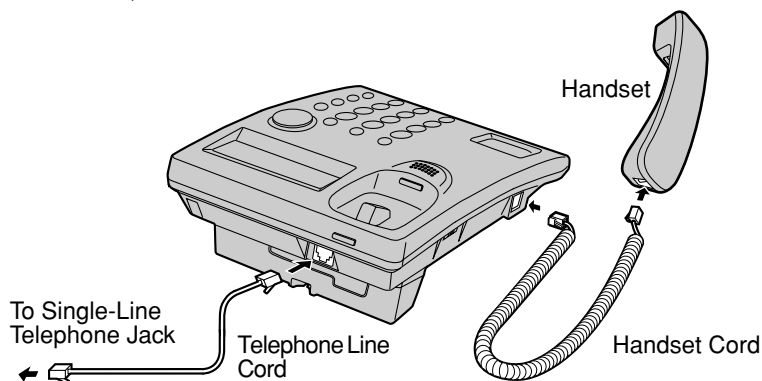

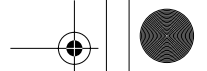

- Use only a Panasonic Handset for the KX-TSC11HGW.
- Use only a telephone line cord included in the unit.
- If your unit is connected to a PBX which does not support Caller ID services, you cannot access those services.

Preparation

## Programming Summary

You can program the following functions. The display shows the programming instructions. See the corresponding pages for function details.

**Make sure that the handset is on the cradle.**

Press .



<Function menu>\*

- |                            |  |
|----------------------------|--|
| SAVE PHONEBOOK ? . . . . . | To store names and phone numbers in memory (p. 20).                    |
| SET CLOCK ? . . . . .      | To adjust the time and date (p. 8).                                    |
| CHANGE PASSWORD? . . . . . | To change the password for the dial lock and call restriction (p. 29). |
| CALL RESTRICT ? . . . . .  | To set the call restriction (p. 31).                                   |
| SET FLASH TIME ? . . . . . | To select the flash time (p. 28).                                      |
| SET DIAL MODE ? . . . . .  | To select the dialing mode (p. 10).                                    |
| LCD CONTRAST ? . . . . .   | To select the LCD contrast (p. 11).                                    |
| CHANGE LANGUAGE? . . . . . | To select the display language (p. 12).                                |

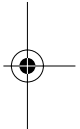

### During programming

- \* To select a desired function item, scroll through the items by pressing [▼] or [▲]. Then press to go to the next step.
- You can exit the programming mode any time by pressing .
- If you do not press any buttons for 60 seconds, the unit will exit the programming mode.

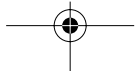



## → Settings

### Time and Date

You can select 24-hour clock or AM/PM by programming.

**Make sure that the handset is on the cradle.**

1 Press .

2 Scroll to "SET CLOCK ?" by pressing or .

SET CLOCK ?

3 Press .

ENTER YEAR 2004  
00:00 31/12

4 Enter the current year.  
(Ex. To set 2004, enter "04".)  
• You can set the year 2000 to 2099.

ENTER YEAR 2004  
00:00 31/12

5 Press .

ENTER TIME  
00:00 31/12

6 Enter the current time (hour and minute) using a 4-digit number.  
(Ex. To set 9:30, enter "0930".)  
• For 24-hour clock: Enter numbers between 0000 and 2359.  
• For AM/PM setting: Enter numbers between 0100 and 1259.

ENTER TIME  
09:30 31/12

7 Press .

- If numbers between 0000 and 0059, or 1300 and 2359 are entered, the time will automatically be set using the 24-hour clock. Go to the step 10.

#=AM/PM  
09:30 31/12





**8** Press [#] to select 24-hour clock, "AM" or "PM".  
(Ex. You select "24-hour clock".)

#=AM/PM  
09:30 31/12

**Display**                      **Option**

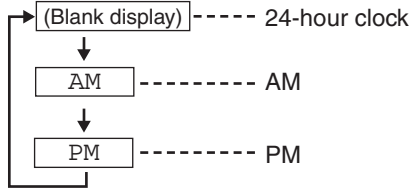

- Each time you press [#], the selection will change on the display.

**9** Press [OK].

ENTER DAY/MONTH  
09:30 31/12

**10** Enter the current day and month using a 4-digit number.  
(Ex. To set Dec. 27, enter "2712".)

ENTER DAY/MONTH  
09:30 27/12

**11** Press [OK].

SAVED

- The clock starts working.
- The display will return to step 2. To exit the programming mode, press [→] or wait for 60 seconds.

- If the time and date entered are not correct, "ERROR" will be displayed and you cannot continue with setting. Enter the correct time and date.

If the batteries installed in the unit expired, the time and date will be shown as "0:00 31/12" or "12:00<sup>AM</sup> 31/12" while talking or after the battery replacement. Readjust the time/date.

**For Caller ID service users (p. 14)**

If a time display service is available with the Caller ID service:  
The Caller ID information will re-set the clock after the ring if the adjusted time and/or date is incorrect. However, if the time/date has not previously been set, the Caller ID information will not adjust the clock.

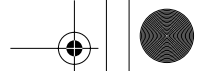

## → Settings

### Dialing Mode

You can select the dialing mode by programming. If you have touch tone service, set to Tone. If rotary or pulse service is used, set to Pulse. Your phone comes from the factory set to Tone.

**Make sure that the handset is on the cradle.**

1 Press

2 Scroll to "SET DIAL MODE ?" by pressing or .

SET DIAL MODE ?

3 Press .

: TONE

4 Select "PULSE" or "TONE" by pressing or .

5 Press .

- The display will return to step 2.
- To exit the programming mode, press or wait for 60 seconds.

SAVED

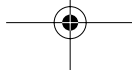

- You can exit the programming mode any time by pressing .



## LCD Contrast

You can select the LCD contrast level from 1 to 4 by programming. Your phone comes from the factory set to 2.





**Make sure that the handset is on the cradle.**



- 1 Press .
- 2 Scroll to "LCD CONTRAST ?" by pressing  or .

LCD CONTRAST ?

- 3 Press .
  - The current setting is displayed.

02

- 4 Select the desired contrast by pressing  or .
  - Each time you press  or , the LCD contrast will change.

- 5 Press .
  - The display will return to step 2. To exit the programming mode, press  or wait for 60 seconds.

SAVED

- You can exit the programming mode any time by pressing .

## Ringer Volume

You can select the ringer volume to HIGH, LOW or OFF. Your phone comes from the factory set to HIGH.

**RINGER Selector:**  
Set to HIGH, LOW or OFF.

RINGER  
HIGH ●●● OFF

• When set to OFF, the unit will not ring.

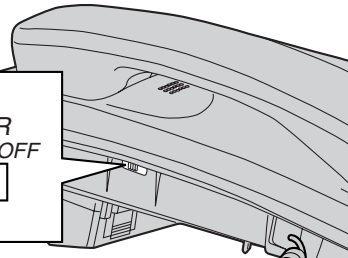

Preparation

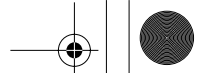

## → Settings

### Display Language

You can select either “English” or “Hungary” as the display language.  
Your phone comes from the factory set to “English”.

**Make sure that the handset is on the cradle.**

1 Press

SAVE PHONEBOOK ?



2 Scroll to “CHANGE LANGUAGE?” by pressing [] or [].

CHANGE LANGUAGE ?

3 Press

: ENGLISH

4 Select “ENGLISH” or “HUNGARIAN” by pressing [] or [].

5 Press

SAVED

- The display will return to step 2.  
To exit the programming mode,  
press or wait for  
60 seconds.

• You can exit the programming mode any time by pressing .

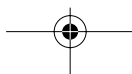

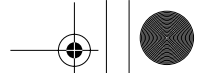

# Making Calls

To make a call, this unit can dial up by 2 methods as below steps.

- 1 Enter a phone number, then lift the handset.  
OR  
Lift the handset, then dial a phone number.

- The dialed number is displayed.
- After a few seconds, the display will show the length of the call.
- If you misdial, hang up and start again from step 1.

|             |
|-------------|
| 1234567890  |
| 12:34 24/11 |

|             |
|-------------|
| 00-00-00    |
| 12:34 24/11 |

- 2 When finished talking, hang up.

## To redial the last number dialed

Lift the handset → press

## To redial using the redial list (Memory Redial)

The last 20 phone numbers dialed are stored in the redial list.

**Make sure that the handset is on the cradle.**

1. Press .
  - The last number dialed and “” are displayed.
  - When the dialed number has been stored in the Phone Book List, the name is displayed instead of the number. To see the number, press [].
2. Select the desired number by pressing [] or [].
  - You can also select through the list by pressing .
  - To exit the list, press [].
3. Lift the handset.
  - The displayed phone number is dialed.
  - To erase an item, repeat steps 1 and 2, and press .
  - If “NO ITEMS STORED” is displayed, the list is empty.

## To adjust the handset volume (4 levels) while talking

To increase, press [].

To decrease, press [].

Ex. Handset volume level: 2

- The display shows the volume level for a few seconds.

|             |
|-------------|
|             |
| 12:34 24/11 |

Basic Operation

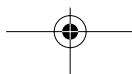

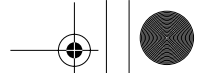

## Answering Calls

When a call is received, the unit rings, "INCOMING CALL" is displayed. If you subscribe to a Caller ID service, the calling party's information will be displayed when the unit is ringing (see below).

1 When the unit rings, lift the handset.

2 When finished talking, hang up.

- When the ringer volume is set to OFF (p. 11), the unit will not ring.

## Caller ID Service

This unit is compatible with a Caller ID service offered by your telephone company. If you subscribe to a Caller ID service, the calling party's information will be displayed when the unit is ringing.

The unit can record information of up to 50 different callers, including the time and date received and the number of times called, in the Caller List. The Caller List information is sorted from the most recent to the oldest call. When the 51st call is received, the oldest call is deleted.

Using the list, you can automatically call back a caller. You can store the callers' numbers from the Caller List in the Phone Book memory.

### How caller information is displayed when a call is received

The display shows the caller's phone number when the unit is ringing.\*

- After you answer the call, the display will show the length of the call.

1114447777

11:50 24/11

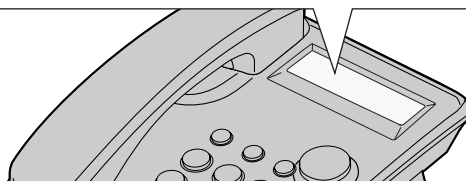

### \*Private name display

If you receive a call from one of the same phone numbers stored in the Phone Book List, the caller's name will be displayed.

- To use this function, names and phone numbers must be stored in the Phone Book List (p. 20).

TINA ROBINSON

11:50 24/11

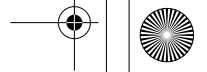

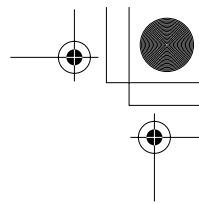
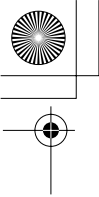

- Caller information will not be displayed in the following cases:
  - If the caller dialed from an area which does not provide a Caller ID service, the display will show "OUT OF AREA".
  - If the caller has requested not to display his/her information, the display will show "PRIVATE CALLER".
  - If a long distance call is identified and caller's name and/or number cannot be received, the display will show "LONG DISTANCE".
- If your unit is connected to a PBX which does not support Caller ID services, you cannot access those services.

- If the batteries installed in the unit have expired, Caller ID services will not be available.
- If the name and the time/date display service is available in your area, the display will show caller's names and the time/date the calls were received. For further information, please contact your telephone company.

Basic Operation

## Using the Caller List



If you have received 10 new calls, the number of new calls will be displayed as shown, while the unit is not in use.

10 MISSED CALLS  
12:34 24/11

## Viewing the Caller List

To check who has called, follow the steps below.

- 1 Press [▼] or [▲] to enter the Caller List.

1114447777  
11:50 24/11 NEW

- 2 To search from the most recent call, press [▼].
  - To search from the oldest call, press [▲].
  - To scroll between callers, press [▼] or [▲].

- 3 To exit the Caller List, press [END].

- If "NO ITEMS STORED" is displayed, the Caller List is empty.
- If more than one call is received from the same caller, the date and time of the most recent call will be recorded.

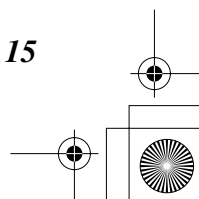
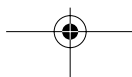
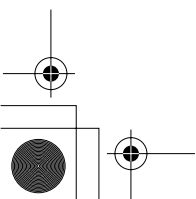

## → Using the Caller List

Ex. When you search from the most recent call:

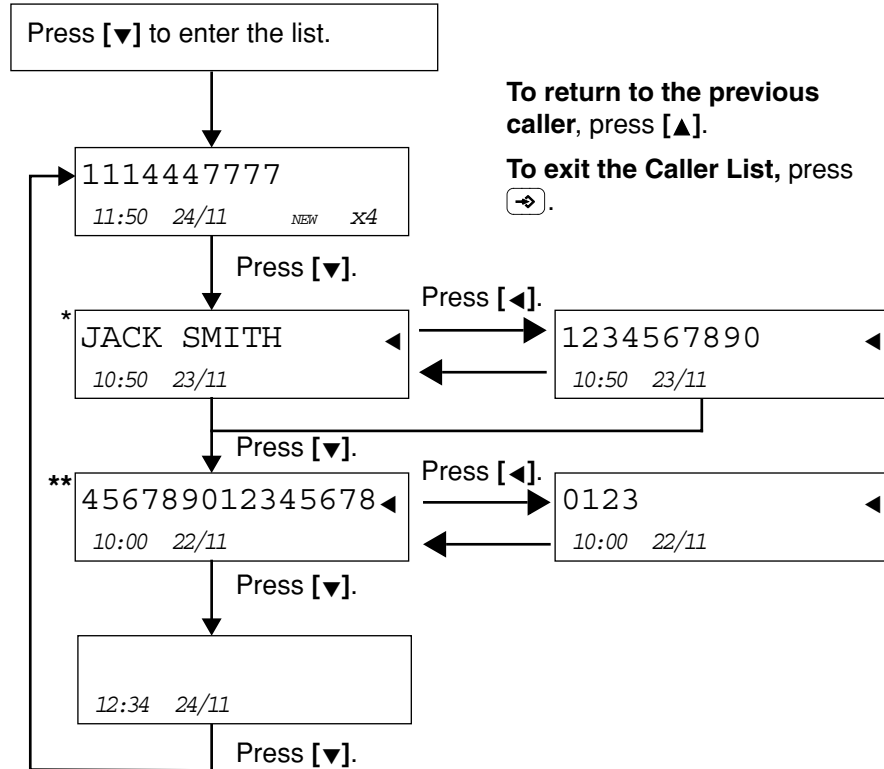

\* If you receive a call from one of the same phone numbers stored in the Phone Book List, the caller's name will be displayed (**Private name display**).

To see the phone number, press [◀]. Each time you press [◀], the display will change alternately.

\*\* If an arrow (◀) is displayed after the number, the whole phone number has not been shown. Press [◀] to see the remaining numbers or to return to the previous display. Each time you press [◀], the display will change alternately.

### Display meaning:

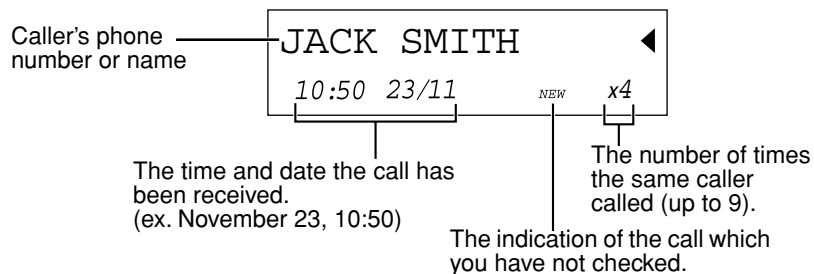



## Calling Back from the Caller List

1 Press [▼] or [▲] to enter the Caller List.

2 Scroll to the desired caller by pressing [▼] or [▲].

- To exit the Caller List, press  or wait for 60 seconds.

|             |
|-------------|
| JACK SMITH  |
| 10:50 23/11 |

3 Lift the handset.

- The displayed phone number is dialed automatically.
- After a few seconds, the display will show the length of the call.

|             |
|-------------|
| 1234567890  |
| 10:50 23/11 |

|             |
|-------------|
| 00-00-00    |
| 10:50 23/11 |

- In some cases, you may have to edit the number before dialing (see below).
- If a phone number is not displayed in the caller information, you cannot call back that caller.

Basic Operation

## Editing the Caller's Phone Number

You can edit a phone number recorded in the Caller List.

1 Press [▼] or [▲] to enter the Caller List.

2 Scroll to the desired caller by pressing [▼] or [▲].

|                    |
|--------------------|
| 1234567890         |
| 10:50 23/11 NEW X4 |

3 Press [▶] or .

### To add a number

Add a number to the current number.

|             |
|-------------|
| 01234567890 |
|-------------|

### To erase a number

Press  or [#] to erase the number.

4 After editing, you can continue with calling back or storing procedures.

To call back, lift the handset.

To store the number in the Phone Book memory, follow steps 4 to 5 on page 18 to complete the operation.

- To exit the Caller List during editing, press  or wait for 60 seconds.

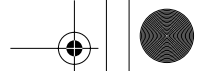

## ➔ Using the Caller List

### Storing Caller List Information in the Phone Book List

You can store numbers in the Caller List to the Phone Book List.

**Make sure that the handset is on the cradle.**

1 Press [▼] or [▲] to enter the Caller List.

2 Scroll to the caller you want to store by pressing [▼] or [▲].

|                    |
|--------------------|
| 1234567890         |
| 10:50 23/11 NEW X4 |

3 Press [▶] or [OK].

- If the number requires editing, see page 17.

|            |
|------------|
| 1234567890 |
|------------|

4 Press [OK].

**If there is no name information for the caller, "ENTER NAME" will be displayed.**

|            |
|------------|
| ENTER NAME |
|------------|

- If a name is required, enter the name (p. 22). When finished, go to step 5.
- If a name is not required, go to step 5.

**If there is name information for the caller, you can edit name information.**

- If you need to change the name, enter the name (p. 22). When finished, go to step 5.
- If you do not need to change the name, go to step 5.

5 Press [OK].

- After a few seconds, the display will return to the Caller List. You can continue storing other items. To exit the Caller List, press [↵] or wait for 60 seconds.

|       |
|-------|
| SAVED |
|-------|

- If the display shows "PHONEBOOK FULL" in step 4, press [↵] to exit the list. To erase other stored items from the Phone Book List, see page 26.
- To cancel during programming, press [↵]. Start again from step 1.
- You cannot store caller information in the Phone Book List if a phone number is not displayed.

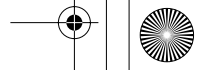

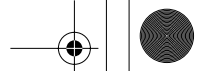

## Erasing Caller List Information

After checking the Caller List, you can erase some or all of the entries.  
**Make sure that the handset is on the cradle.**

### To erase a specific caller from the Caller List

1 Press [▼] or [▲] to enter the Caller List.

2 Scroll to the caller you want to erase by pressing [▼] or [▲].

JACK SMITH  
 10:50 23/11

3 Press [C].

- The information is erased.
- After a few seconds, the display will show the previous caller information.
- To exit the Caller List, press [↵] or wait for 60 seconds.

ERASED

Basic Operation

### To erase all entries in the Caller List

1 Press [C].  
 • To stop erasing, press [↵].

ALL ERASE ?

2 Press [OK].  
 • All entries are erased.  
 • The unit will exit the Caller List.

ALL ERASED

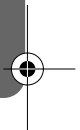

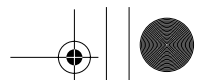

# Phone Book

## Storing Names and Phone Numbers in the Phone Book List

You can store up to 50 names and phone numbers in the Phone Book.  
**Make sure that the handset is on the cradle.**

1 Press .

SAVE PHONEBOOK ?

2 Press .

- The display will show the number of stored items.
- After a few second the display will change.

12 ITEMS STORED

3 Enter a name, up to 15 characters with the dialing buttons (p. 22).

- To move the cursor while entering name, press or .
- If a name is not required, press and go to step 5.

ENTER NAME

4 Press .

- If you want to return to step 3 for editing, press .

ENTER PHONE NO.

5 Enter a phone number up to 22 digits.

- If you entered a wrong number, press and enter the correct number.
- To move the cursor while entering number, press or .

1234567890

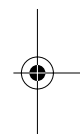

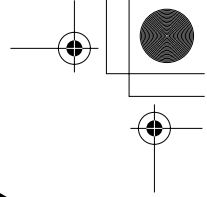
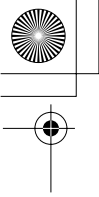

## 6 Press **OK**.

- To continue storing other items, repeat from step 2.
- The display will return to step 1. To exit the programming mode, press **EXIT** or wait for 60 seconds.



- If the display shows "PHONEBOOK FULL" in step 2, press **EXIT** to exit. To erase other stored items from the Phone Book List, see page 26.
- You can exit the programming mode any time by pressing **EXIT**.
- If a pause is required for dialing, press **PAUSE** where needed. If required, you can also store **R** in a phone number. Pressing **PAUSE** or **R** counts as one digit (p. 27, 28).
- To store numbers for calling card access (see "Chain Dial" on page 24), we recommend you add pauses after each item. Storing pauses with numbers will prevent misdialing (p. 27). The delay time necessary will depend on your telephone company.
- When using the Dial Lock (p. 30) or Call Restriction feature (p. 31), you cannot store the emergency number in the Phone Book.
- If the display shows "DIAL LOCKED" or "CALL RESTRICTED" in step 4, you cannot store the emergency number in the Phone Book. See page 30, 31.
- When the dialing buttons are locked (p. 30), only numbers stored in the Phone Book as emergency numbers can be dialed.
- When storing a name, you can also enter space by pressing **[0]** twice. Items with space at the beginning will be displayed with first priority. See page 23.

### To store an emergency number:

When storing a name in step 3 on page 20, enter # at the beginning of the name by pressing **[#]**. See page 22.

- Items with # at the beginning will be displayed with first priority if DIAL LOCK or CALL RESTRICTION is set to ON. See page 30, 31.

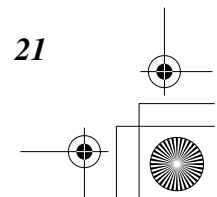
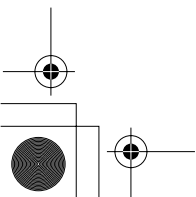

## → Phone Book

### Selecting characters to enter names

The dialing buttons ([0] to [9]) can be used to enter letters and symbols. Pressing each button selects a character as shown below.

| Keys | Number of times key is pressed  |       |   |   |   |   |   |   |   |
|------|---------------------------------|-------|---|---|---|---|---|---|---|
|      | 1                               | 2     | 3 | 4 | 5 | 6 | 7 | 8 | 9 |
| [1]  | &                               | '     | ( | ) | , | - | . | / | 1 |
| [2]  | A                               | B     | C | 2 |   |   |   |   |   |
| [3]  | D                               | E     | F | 3 |   |   |   |   |   |
| [4]  | G                               | H     | I | 4 |   |   |   |   |   |
| [5]  | J                               | K     | L | 5 |   |   |   |   |   |
| [6]  | M                               | N     | O | 6 |   |   |   |   |   |
| [7]  | P                               | Q     | R | S | 7 |   |   |   |   |
| [8]  | T                               | U     | V | 8 |   |   |   |   |   |
| [9]  | W                               | X     | Y | Z | 9 |   |   |   |   |
| [*]  | *                               |       |   |   |   |   |   |   |   |
| [0]  | 0                               | Space |   |   |   |   |   |   |   |
| [#]  | #                               |       |   |   |   |   |   |   |   |
| [◀]  | To move the cursor to the left  |       |   |   |   |   |   |   |   |
| [▶]  | To move the cursor to the right |       |   |   |   |   |   |   |   |

### If you make a mistake while entering a name

Use [◀] or [▶] to move the cursor to the incorrect character, press **C** to delete and enter the correct character. Each time you press **C**, a character is erased.

### For example, to enter "TOM JONES":

- 1 Press [8].
- 2 Press [6] three times, then press [▶].
- 3 Press [6] once, then press [▶] twice.
- 4 Press [5], press [6] three times, then press [▶].
- 5 Press [6] twice, press [3] twice, then press [7] four times.

|           |
|-----------|
| T         |
| TO        |
| TOM       |
| TOM JO    |
| TOM JONES |



## Dialing from the Phone Book

Make sure that the handset is on the cradle.

- 1 Press [◀] or [▶] to enter the Phone Book List.

PHONEBOOK LIST



- 2 Scroll to the desired item by pressing [▼] or [▲].

- All Phone Book items are stored in the order shown on the right.

### To search for a name by initial:

1. Press the dialing button for the first letter of the desired name until any name with the same initial is displayed (see the Index table on page 24).

Ex. To find "Frank", press [3] repeatedly until the first item under "F" is displayed.

2. Press [▼] repeatedly until the name is displayed.

- Items with # at the beginning will be displayed with first priority if DIAL LOCK or CALL RESTRICTION is set to ON.

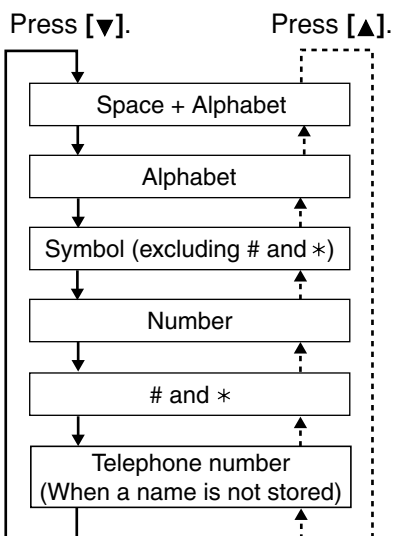

- 3 Lift the handset.
  - The number is dialed automatically.

- 4 To hang up, place the handset on the cradle.

Advanced Operation

- If "NO ITEMS STORED" is displayed in step 1, the Phone Book is empty.
- You can exit the Phone Book List any time by pressing [↵].
- You can also dial the stored number as follows:
  1. Lift the handset.
  2. Find the desired item (above step).
  3. Press [OK].
- If there is no battery, this function will not operate.

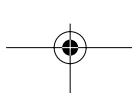



## ➔ Phone Book

### Index table

| Keys | Index      | Keys | Index         |
|------|------------|------|---------------|
| [1]  | Symbols, 1 | [7]  | P, Q, R, S, 7 |
| [2]  | A, B, C, 2 | [8]  | T, U, V, 8    |
| [3]  | D, E, F, 3 | [9]  | W, X, Y, Z, 9 |
| [4]  | G, H, I, 4 | [*]  | *             |
| [5]  | J, K, L, 5 | [0]  | 0, Space      |
| [6]  | M, N, O, 6 | [#]  | #             |

### Chain Dial

You can dial a combination of the Phone Book or manual key pad entries while making a call. This feature can be used, for example, to first automatically dial a calling card access number that you have stored in the Phone Book, then manually or automatically dial your PIN and then automatically dial the destination number from the Phone Book.

Ex. Using a long distance calling card

- To prevent misdialing, we recommend you add pauses where needed when storing numbers. For example, add pauses after a calling card access number and your PIN when storing in the Phone Book (p. 21).
1. Search and dial from the Phone Book: 18000123456 (Calling card access number)
    - The voice guidance may be announced.
  2. Search and dial from the Phone Book: 1234 (Calling card PIN)
  3. Search and dial from the Phone Book: 15550123456 (Destination number)

**1 While you are on a call;**  
Press [◀] or [▶].

**2** Search for the desired item by pressing [▼] or [▲].  
• To search for an item by initial, see page 23.

**3** Press [OK].  
• The phone number is dialed.  
• If required, repeat steps 1 to 3 for any remaining numbers.

- If you have rotary or pulse service, you need to press [\*] before pressing [◀] or [▶] in step 1 to change the dialing mode temporarily to tone.

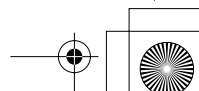



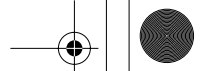

## Editing

**Make sure that the handset is on the cradle.**

1 Press [◀] or [▶] to enter the Phone Book List.

2 Scroll to the Phone Book item you want to change by pressing [▼] or [▲].

- To search for the item by initial, see page 23.

3 Press [▶] or [OK].

- If you do not need to change the name, go to step 5.

4 Edit the name using the dialing buttons (p. 22).

- To clear an incorrect character, move the cursor to the character by using [◀] or [▶], then press [C].

5 Press [OK].

**To add a number**

Add a number to the current number.

**To erase a number**

Press [C] to erase the number.

- To move the cursor, press [◀] or [▶].

6 Press [OK].

- To continue editing other items repeat from step 2.

Advanced Operation

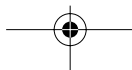
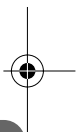

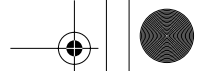

## → Phone Book

---

### Erasing

**Make sure that the handset is on the cradle.**

- 1 Press [◀] or [▶] to enter the Phone Book List.
- 2 Scroll to the Phone Book item that you want to erase by pressing [▼] or [▲].
  - To search for the item by initial, see page 23.

- 3 Press [C].
  - To stop erasing, press [◀].

ERASE ?  
B

- 4 Press [OK].
  - To erase other items, repeat from step 2.
  - To exit the Phone Book List, press [→].

ERASED  
B

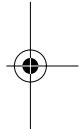
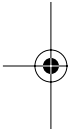

## Special Features

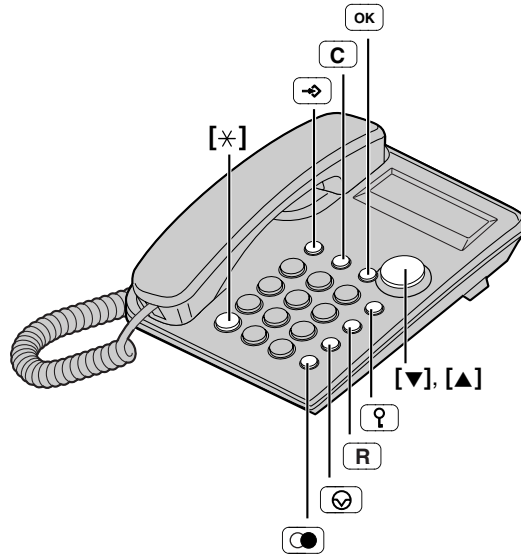

### Temporary Tone Dialing (For Rotary or Pulse Service Users)

Press [\*] (TONE) before entering access numbers which require tone dialing.

- The dialing mode changes to tone. You can enter numbers to access an answering service, electronic banking service, etc. When you hang up, the mode will return to pulse.

### Using the PAUSE Button (For PBX Line/Long Distance Calls)

We recommend you press [Ⓜ] if a pause is required for dialing with a PBX or to make a long distance call.

Ex. Line access number [9] (PBX)

[9] → [Ⓜ] → Phone number

- Pressing [Ⓜ] once creates a 3.5 second pause. This prevents misdialing when you redial or dial a stored number.
- Pressing [Ⓜ] more than once increases the length of the pause between numbers.

Advanced Operation

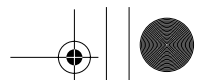

## ➔ Special Features

### For Call Waiting Service Users

Press **[R]** if you hear a call-waiting tone while talking.

- The first call is put on hold and you can answer the second call.
- To return to the first caller, press **[R]** again.
- The call waiting service cannot be used when a parallel connected telephone is in use.
- If this function does not operate properly, consult your telephone company for details.

### RECALL Button

Pressing **[R]** allows you to use special features of your host PBX such as transferring an extension call or accessing special telephone services (optional) such as call waiting.

#### Selecting the recall time

The recall time depends on your telephone exchange or host PBX. You can select the following recall times: “80, 90, 100, 110, 200, 250, 300, 400, 600, 700 ms (milliseconds)”. Your phone comes from the factory set to “600 ms”.

**Make sure that the handset is on the cradle.**

1 Press **[↔]**.

2 Scroll to “SET FLASH TIME ?” by pressing **[▼]** or **[▲]**.

SET FLASH TIME ?

3 Press **[OK]**.

: 600MS

4 Select the desired time by pressing **[▼]** or **[▲]**.

5 Press **[OK]**.

SAVED

- The display will return to step 2. To exit the programming mode, press **[↔]** or wait for 60 seconds.

- You can exit the programming mode any time by pressing **[↔]**.
- If the unit is connected via a PBX, PBX functions (transferring a call, etc.) might not work correctly. Consult your PBX supplier for the correct setting.
- If there is no battery, Flash function may not operate appropriately.

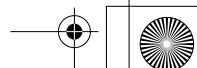

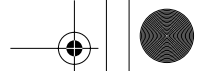

## Setting the Password

You can change the password for the dial lock and call restriction.  
The factory preset password is "1111".

### To set the password

Make sure that the handset is on the cradle.

1 Press

2 Scroll to "CHANGE PASSWORD?" by pressing [] or [].

CHANGE PASSWORD?

3 Press

CURRENT PASSWORD

4 Enter the current password.

: \*\*\*

5 Press

- If the wrong password was entered at step 4, "ERROR" will be displayed, then "----" will be displayed. Enter the correct password.

NEW PASSWORD

6 Enter a new password using a 4-digit number. (Ex. "1234" is entered.)

: 1234

7 Press

- The display will return to step 2. To exit the programming mode, press or wait for 60 seconds.

SAVED

- You can exit the programming mode any time by pressing .

Advanced Operation

Please write down your password. If you forget your password, consult your nearest Panasonic service center.

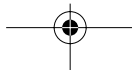

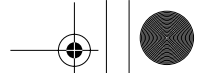

## ➔ Special Features

### Dial Lock

The Dial Lock feature allows you to prevent others from making calls. To use this feature, turn the feature ON. The factory preset is OFF.

Before using the Dial Lock or Call Restriction feature (p. 31), we recommend storing emergency numbers in the Phone Book (p. 20, 21). When the Dial Lock is ON, only numbers stored in the Phone Book as emergency numbers can be dialed.

#### To set the dial lock

- 1 Press **[Q]**.  
• “Q” flashes on the display.

ENTER PASSWORD



- 2 Enter the password (p. 29).

: \*\*\*\*\*



- 3 Press **[OK]**.  
• “Q” displays.  
• If the wrong password was entered, “ERROR” will be displayed, then “- - - -” will be displayed. Enter the correct password.

If the dial buttons are pressed after lifting the handset, “DIAL LOCKED” will be displayed.

You can use the following features while the dialing buttons are locked.

- Dialing # emergency items which programmed into the memory of the Phone Book by pressing **[▼]** (p. 21)
- Selecting the ringer volume (p. 11)
- Adjusting the handset volumes (p. 13)
- Answering the second call by pressing **[R]** (p. 28)
- Programming (except storing/erasing # emergency items in the Phone Book List)
- Finding an item in the following lists
  - Caller list (p. 15)
  - Phone Book List (p. 23)
  - Redial list (p. 13)

#### To cancel the dial lock

Follow above steps 1 through 3. In step 3, “Q” will go out.

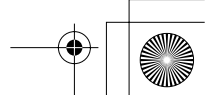
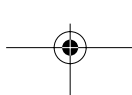





## Call Restriction

You can prevent the unit from dialing phone numbers beginning with specified digit(s) (1 digit or 2 digits). Phone numbers with the restricted leading digits cannot be dialed out except the emergency numbers stored in the Phone Book.

### To set the call restriction

Make sure that the handset is on the cradle.

- 1 Press .
- 2 Scroll to "CALL RESTRICT ?" by pressing  or .
- 3 Press .

CALL RESTRICT ?

RESTRICT NO. : 

If you changed the password "1111" (factory set), the display on the right will be shown. Follow below steps 1 and 2.



1. Enter the password (p. 29).
  2. Press . Go to step 4.
- If the wrong password was entered, "ERROR" will be displayed, then "----" will be displayed. Enter the correct password.

ENTER PASSWORD

: \*\*\*

- 4 Enter the number(s) (1 digit or 2 digits) you want to restrict (**[0]** to **[9]**).
  - If the wrong number was entered, press  and enter the correct number.

RESTRICT NO. : 9



- 5 Press .
  - The display will return to step 2. To exit the programming mode, press  or wait for 60 seconds.

SAVED

Advanced Operation

- When dialing a phone number with the restricted leading digit(s), "CALL RESTRICTED" is displayed.
- If the display shows "CALL RESTRICTED", you cannot store the emergency numbers in the Phone Book.

### To cancel the call restriction

Follow steps 1 through 3. In step 4, press  to clear the restricted digits, and press .

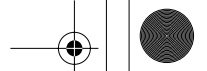

# Wall Mounting

This unit can be mounted on a wall.

- 1 Press the tabs in the direction of the arrows (①), then remove the wall mounting adaptor (②).

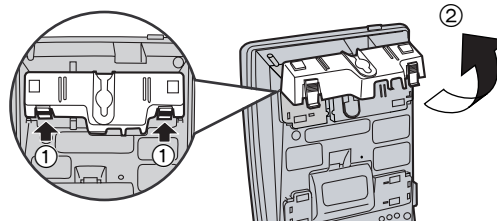

- 2 Tuck the telephone line cord inside the wall mounting adaptor, and push it in the direction of the arrow (① and ②).
  - The word "UP WALL" should face upward.

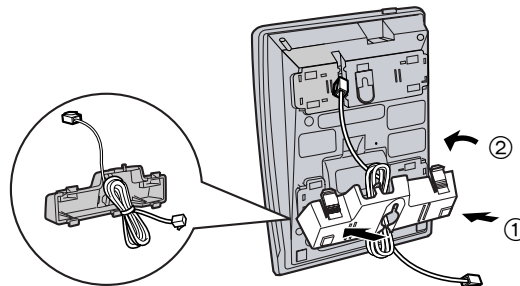

- 3 Install screws using the wall template below. Connect the telephone line cord. Mount the unit, and slide down.

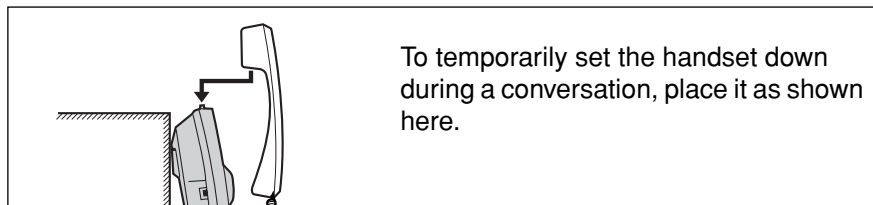
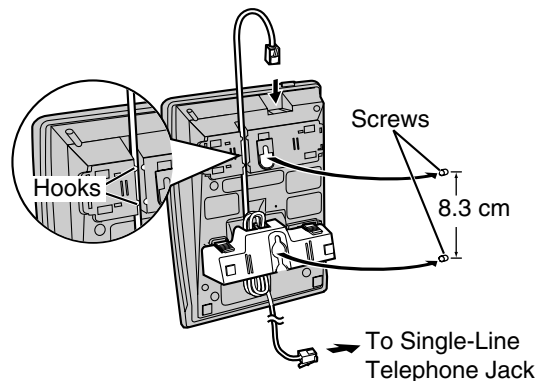

## Wall Template

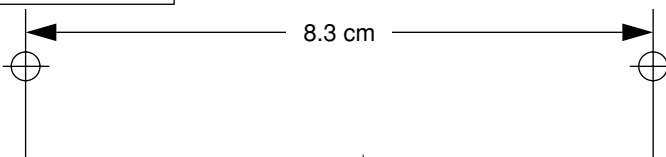



## Battery Replacement

If “□” flashes, the battery power is low. Install new batteries as soon as possible.

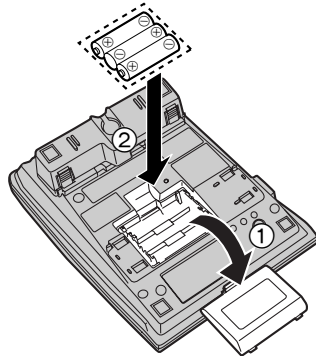

- 1 Disconnect the telephone line cord from the unit.
- 2 Press down in the direction of the arrow and remove the battery cover (①).
- 3 Replace the batteries with new ones using correct polarity (+, -) (②), and close the battery cover.
- 4 Connect the telephone line cord to the unit.

- After the battery replacement, the information stored in the Redial List will be cleared. Store the desired item in the Phone Book List and Caller List.
- The time will be shown as “0 : 00 31/12” or “12 : 00<sup>AM</sup> 31/12” after replacing the batteries, readjust the time and date.

### Battery Precautions:

The batteries should be used correctly, otherwise the unit may be damaged by battery leakage.

- Do not mix different types of batteries.
- Do not charge, short-circuit, disassemble, heat or dispose of in fire.
- Remove all the batteries when replacing.

### Note:

- If you do not install the batteries or if the battery power is low, the time will be shown as “0 : 00 31/12” or “12 : 00<sup>AM</sup> 31/12”. Readjust the time and date after the battery replacement.
- Replace all the batteries every six months if using Alkaline batteries, or misoperation may occur. (When you use Manganese batteries, replace all of them every three months.)
- Do not use nickel-cadmium batteries.

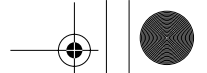

## Troubleshooting

| Problem   | Cause and Remedy   |
|---|--|
| The unit does not work.                             | <ul style="list-style-type: none"> <li>• Check the settings (p. 6 – 12).</li> <li>• Remove the batteries and reinstall them to reset the unit.</li> </ul>  |
| The unit does not ring.                             | <ul style="list-style-type: none"> <li>• The ringer selector is set to OFF. Set to HIGH or LOW (p. 11).</li> </ul>   |
| The display is blank.                               | <ul style="list-style-type: none"> <li>• Install new batteries (p. 33).</li> </ul>   |
| You cannot dial.                                    | <ul style="list-style-type: none"> <li>• Check that the dialing mode selection is correct (p. 10).</li> <li>• Dial lock mode is set. To cancel the mode, see page 30.</li> <li>• The dialed number is restricted. To cancel, see page 31.</li> </ul>   |
| You cannot program items such as the dialing mode.  | <ul style="list-style-type: none"> <li>• Programming is not possible when the handset is off the cradle.</li> <li>• Do not pause for over 60 seconds while programming.</li> </ul>   |
| You cannot store a name and phone number in memory. | <ul style="list-style-type: none"> <li>• When using the Dial Lock (p. 30) or Call Restriction feature (p. 31), you cannot store an emergency number in the Phone Book List.</li> <li>• If "PHONEBOOK FULL" is displayed, erase other stored items from the Phone Book List (p. 26).</li> <li>• Programming is not possible when the handset is off the cradle.</li> <li>• Check that the batteries are installed in the unit and that the battery power is not low.</li> <li>• Do not pause for over 60 seconds while storing.</li> <li>• Do not enter a phone number more than 22 digits long.</li> </ul> |

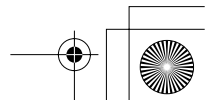
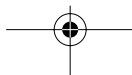
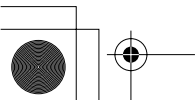
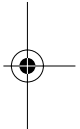

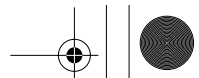

| Problem   | Cause and Remedy  |
|---|---|
| While programming or searching, the unit starts to ring and stops the program/ search.                              | <ul style="list-style-type: none"> <li>• To answer the call, lift the handset. Start again from the beginning after hanging up.</li> </ul>  |
| The unit does not display the caller's phone number.  | <ul style="list-style-type: none"> <li>• You need to subscribe to a Caller ID service.</li> <li>• Install or replace the batteries.</li> <li>• Other telephone equipment may be interfering with your phone. Disconnect it and try again.</li> <li>• Telephone line noise may be interfering with the Caller ID information. Consult your telephone company.</li> </ul> |
| The display exits the Caller List.  | <ul style="list-style-type: none"> <li>• Do not pause for over 60 seconds while searching.</li> </ul>   |
| You cannot redial by pressing  . | <ul style="list-style-type: none"> <li>• If the last number dialed was more than 32 digits long, the number will not be redialed correctly.</li> </ul>  |
| Information stored in the Redial List is erased.  | <ul style="list-style-type: none"> <li>• If "☐" flashes, replace the batteries as soon as possible. Otherwise, information stored in the Redial List may be erased. Store the desired item in the Phone Book List, if necessary.</li> </ul>   |

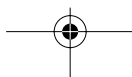
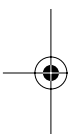

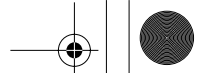

# Safety Instructions

Take special care to follow the safety suggestions listed below.

## Installations

### Environment

- 1) Do not use this unit near water—for example, near a bathtub, washbowl, sink, etc. Damp basements should also be avoided.
- 2) The unit should be kept away from heat sources such as radiators, kitchen range, etc. It also should not be placed in rooms where the temperature is less than 5°C or greater than 40°C.

### Placement

- 1) Do not place heavy objects on top of this unit.
- 2) Care should be taken so that objects do not fall onto, and liquids are not spilled into the unit. Do not subject this unit to excessive smoke, dust, mechanical vibration or shock.
- 3) Place the unit on a flat surface.

### CAUTION:

To reduce the risk of fire or injury to persons, read and follow these instructions.

1. Use only the battery(ies) specified.
2. Do not dispose of the battery(ies) in a fire. It (they) may explode.
3. Do not open or mutilate the battery(ies). Released electrolyte is corrosive and may cause burns or injury to the eyes or skin. The electrolyte may be toxic if swallowed.
4. Exercise care in handling the battery(ies) in order not to short the battery(ies) to conductive materials such as rings, bracelets, and keys. The battery(ies) and/or conductor may overheat and cause burns.
5. Do not recharge the battery(ies) provided with or identified for use with this product. The battery(ies) may leak corrosive electrolyte or explode.
6. Do not attempt to rejuvenate the battery(ies) provided with or identified for use with this product by heating. Sudden release of battery electrolyte may occur causing burns or irritation to the eyes or skin.
7. Replace all batteries at the same time. Mixing fresh and discharged batteries could increase internal cell pressure and rupture the discharged batteries. (Applies to products employing more than one separately replaceable primary battery.)
8. When installing batteries observe the proper polarity or direction. Incorrect installation can cause charging, and may result in leakage or explosion. (Applies to products employing more than one separately replaceable primary battery.)
9. Remove the battery(ies) from this product if the product will not be used for a long period of time (several months or more). During this time the battery(ies) could leak in the product.
10. Discard the dead battery(ies) as soon as possible. The dead battery(ies) may leak in the product.
11. Do not store this product, or the battery(ies) provided with or identified for use with this product, in high temperature areas. Batteries that are stored in a freezer or refrigerator for the purpose of extending shelf life should be protected from condensation during storage and defrosting. Batteries should be stabilized at room temperature prior to use after cold storage.



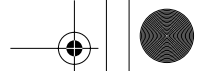

---

### Lightning surge

This unit has already been equipped with a built-in lightning protection circuit. However, we recommend you to install lightning protection on the telephone line, if your area has a high incidence of lightning strikes.

### WARNING:

TO PREVENT FIRE OR SHOCK HAZARD, DO NOT EXPOSE THIS PRODUCT TO RAIN OR ANY TYPE OF MOISTURE.

If there is any trouble, disconnect the unit from the telephone line and connect a known working phone. If the known working phone operates properly, do not reconnect the unit to the telephone line until the trouble has been repaired. If the known working phone does not operate properly, consult your telephone company.

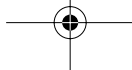

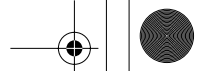

# Specifications

- Power Source:** From 3 AA (R6, UM-3, LR6) batteries
- Dimensions (H x W x D):** Approx. 96 mm x 150 mm x 200 mm
- Mass (Weight):** Approx. 550 g
- Dialing Mode:** Tone (DTMF)/Pulse
- Operating Environment:** 5 °C – 40 °C

Specifications are subject to change without notice.

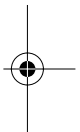

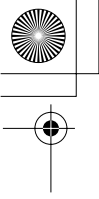

E-PQQX14361ZA.book 39 ページ 2004年10月20日 水曜日 午後1時52分

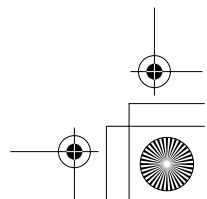
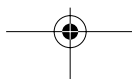
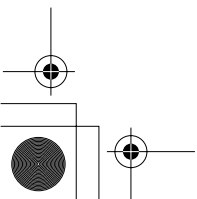
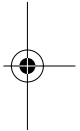
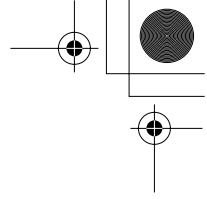

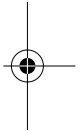
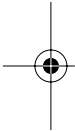
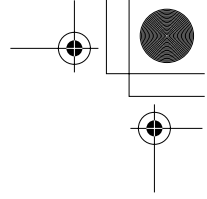
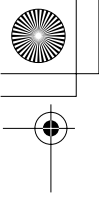

This equipment is designed for use on Hungary only.

In the event of problems, you should contact your equipment supplier in the first instance.

Manufactured by Panasonic Communications (Malaysia) Sdn. Bhd.  
Senai Malaysia

**PQQX14361ZA** F1004-0 ①

